

Extra Shelves - 2 x 500mm

NPS05

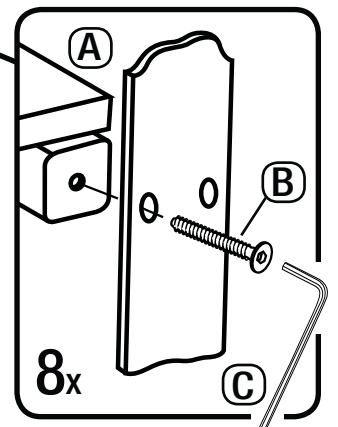
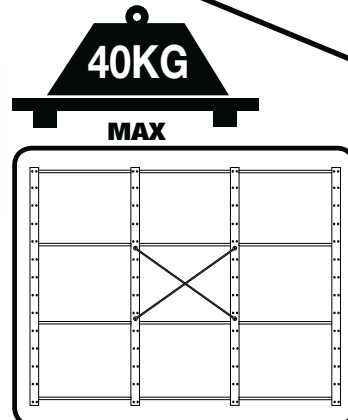
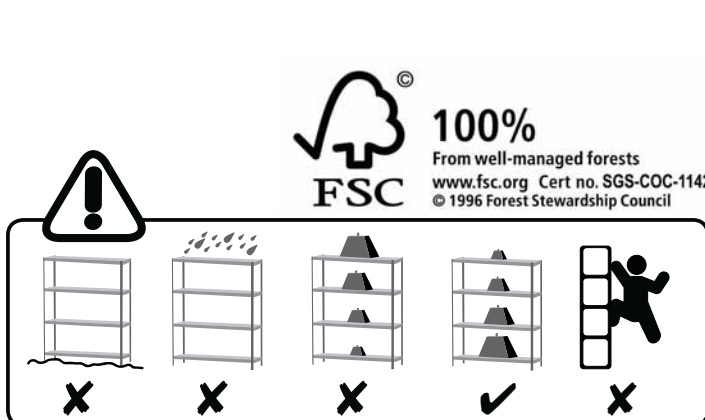
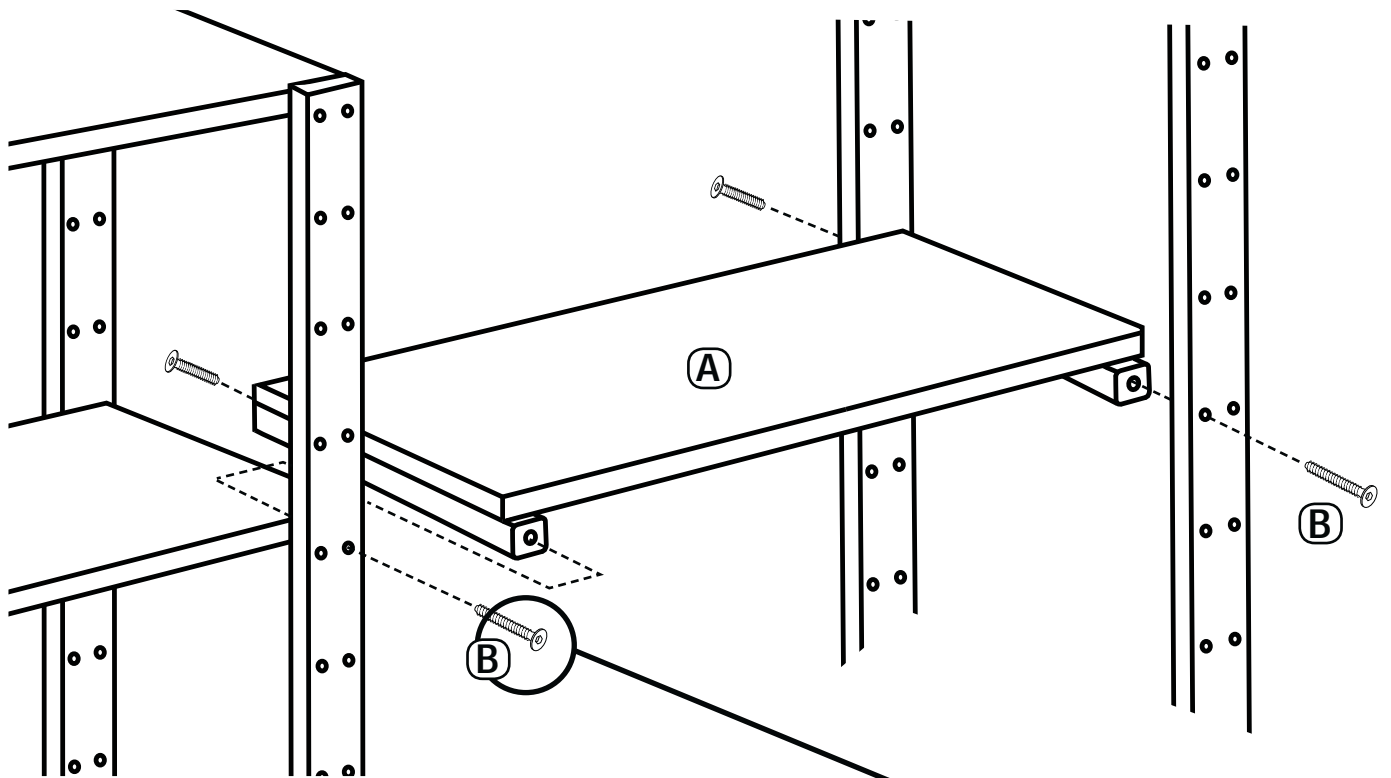
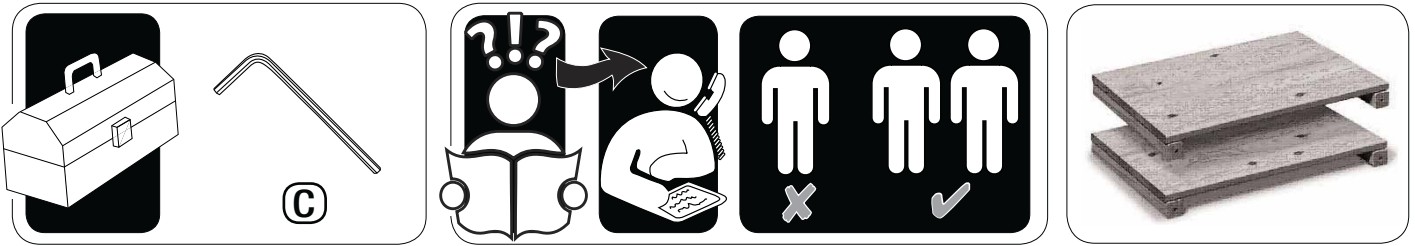
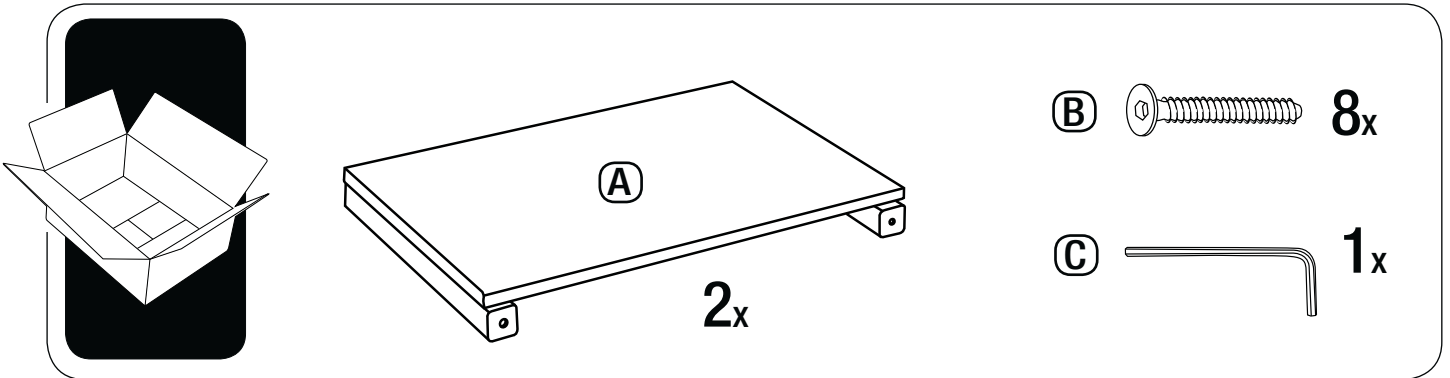

NATURAL PINE SHELVING SYSTEM

- Solid Natural Pine shelving from sustainable sources
- Modular system – easy to extend shelving when needed
- Choose corner units, wine bottle shelves or mobile crates to create a custom storage solution
- Made from FSC certified timber
- Simple assembly with minimal tools
- Shelves and posts have rounded edges for a neat, smooth finish
- Pre-sanded timber - ready to paint, stain or varnish
- Each adjustable pine shelf supports up to 40kg UDL*

*UDL = Uniformly distributed load



Important!

Pine is a natural material and as such there are always small variations in colour and finish. Any visible knots won't affect the structure or strength of the shelving and add to its character.

We recommend that this shelving is waxed, stained, varnished or painted to seal the timber and prevent marking.

Please remember to recycle this product at the end of its useful life.



PARTS LIST

Part No. Description

NPS4	Pine shelf unit with 4 solid shelves and cross-brace
NPS08	Pack of 2 solid pine shelves 900w x 400mm d
NPS05	Pack of 2 solid pine shelves 500w x 400mm d
NPWS08	Pack of 2 wine bottle shelves 900w x 400mm d
NPCS	Pair of 2 solid pine corner shelves 900w x 400mm d
NPBW	Pine storage crate on wheels 400h x 700w x 350mm d
NPUS	Pack of 2 pine posts 1160mm h
NPUT	Pack of 2 pine posts 1800mm h
NPCB	Cross-brace for shelving units – use every four bays



100%

From well-managed forests

www.fsc.org Cert no. SGS-COC-1142
© 1996 Forest Stewardship Council